

Data sheet | Item number: 286-895

Switching module; with changeover rocker switch; Switching voltage: 250 VAC; Switching current: 6 A; gray

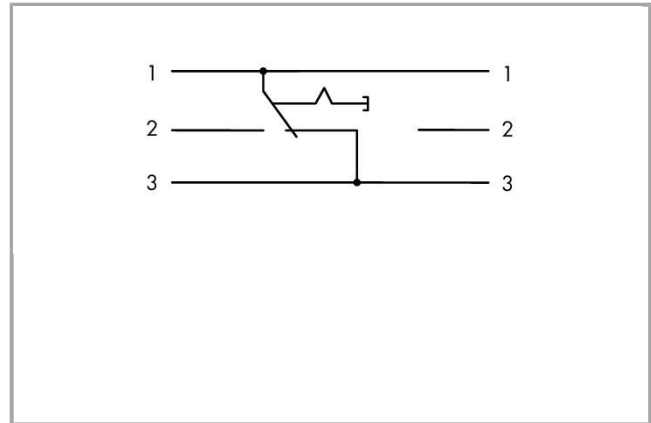

286-895



RoHS Compliant

[BOMcheck.net](https://www.bomcheck.net)

Color:

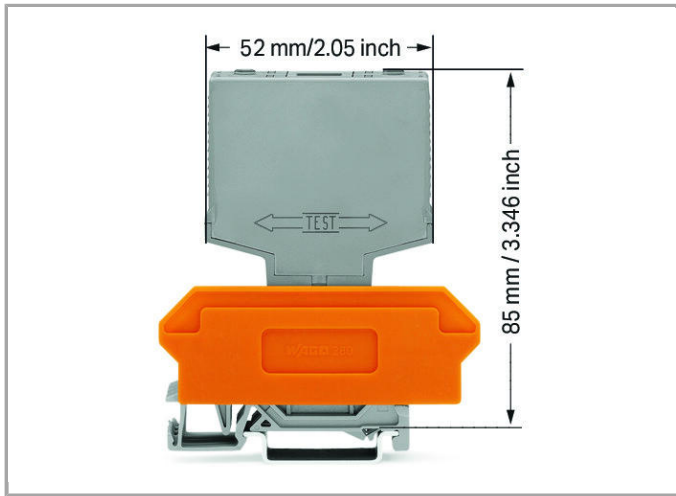

Data

Electrical data

Max. switching current (resistive)	6 A
Max. switching voltage	AC 250 V; DC 24 V
Contact gap	≥ 3 mm
Electrical life (N.O.; resistive load; 23 °C)	50 x 10 ³ switching operations

Geometrical Data

Width	15 mm / 0.591 inch
Height from upper-edge of DIN-35 rail	85 mm / 3.346 inch
Depth	52 mm / 2.047 inch

Mechanical data

Type of mounting	Pluggable module for carrier terminal blocks
Housing design	Pluggable module for terminal blocks

Material Data

Color	gray
Fire load	0.404 MJ
Weight	20.5 g

Environmental Requirements

Surrounding air (operating) temperature at U _N	-20 40 °C
-----------------------------------------------------------	-----------



Commercial data

Product Group	6 (Interface Electronics)
---------------	---------------------------









Country of origin	DE
GTIN	4045454399801
Customs Tariff No.	85365080990

Compatible products

General accessories

	Item no.: 280-609 Terminal block for pluggable modules; 12-pole; with 4-conductor terminal blocks; with orange separator; for DIN-rail 35 x 15 and 35 x 7.5; 2.5 mm ² ; CAGE CLAMP®; 2,50 mm2; gray	280-609
	Item no.: 280-619 Terminal block for pluggable modules; 6-pole; with 2-conductor terminal blocks; with orange separator; for DIN-rail 35 x 15 and 35 x 7.5; 2.5 mm ² ; CAGE CLAMP®; 2,50 mm2; gray	280-619
	Item no.: 280-763 Terminal block for pluggable modules; 12-pole; with 4-conductor terminal blocks; with marker carrier; with orange separator; for DIN-rail 35 x 15 and 35 x 7.5; 2.5 mm ² ; CAGE CLAMP®; 2,50 mm2; gray	280-763

Marking accessories

	Item no.: 209-701 WSB marking card; as card; not stretchable; plain; snap-on type; white	209-701
	Item no.: 209-701/000-002 WSB marking card; as card; not stretchable; plain; snap-on type; white	209-701 /000-002
	Item no.: 209-701/000-005 WSB marking card; as card; not stretchable; plain; snap-on type; white	209-701 /000-005
	Item no.: 209-701/000-006 WSB marking card; as card; not stretchable; plain; snap-on type; white	209-701 /000-006
	Item no.: 209-701/000-007 WSB marking card; as card; not stretchable; plain; snap-on type; white	209-701 /000-007
	Item no.: 209-701/000-012 WSB marking card; as card; not stretchable; plain; snap-on type; white	209-701 /000-012
	Item no.: 209-701/000-017 WSB marking card; as card; not stretchable; plain; snap-on type; white	209-701 /000-017
	Item no.: 209-701/000-023 WSB marking card; as card; not stretchable; plain; snap-on type; white	209-701 /000-023
	Item no.: 209-701/000-024 WSB marking card; as card; not stretchable; plain; snap-on type; white	209-701 /000-024



Downloads

Documentation

Bid Text

286-895 Interface-Bausteine mit Sonderfunktionen	Jan 15, 2016	doc 24.6 kB	Download
-----------------------------------------------------	--------------	----------------	----------

Additional Information

Disposal; Electrical and electronic equipment, Packaging	V 1.0.0	pdf 265.8 kB	Download
----------------------------------------------------------	---------	-----------------	----------

CAD/CAE - Smart Data

CAD data

3D Download 286-895		URL	Download
---------------------	--	-----	----------

WSCAD

WSCAD Universe			Download
----------------	--	--	----------

Subject to changes.
